

DANCOVER

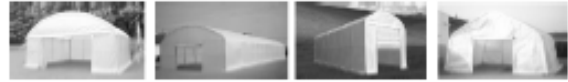

SHELTER

Installation Manual

MODEL: Basic-2027

L8.0xW3.5xH3.8M

www.Dancover.com

Phone: +45 70 26 76 20



Congratulations on your purchase of our instant shelter. This unit is a combination of excellent manufacturing and design. It is comprised of a rigid frame and a durable cover. For easy assembly, we have marked all the parts with codes. With proper installation, use and maintenance, your unit will provide many years of good and suitable service.

READ ALL THE INSTRUCTIONS BEFORE ASSEMBLY !

1. The proper erection and installation of this building requires a high level of care and safety. We recommend the safety regulations be complied with during the installation. It includes but is not limited to:
 - Safety hats, protective eyewear and protective clothing
 - Safety harnesses for all elevated workers
 - Proper ladder, cage, and safety operation
2. Site selection: Choose a solid level location for your building. Do not install the building where the ground could not keep the building steady. Do not install the building where the ground could not bear the weight of the building. Do not install the building in soft grass ground or wetland.
3. Be cautious with the surroundings. Keep work area clean. Do not set up it near snow drifts, in slippery places, or in wet location. The cover of the building will protect against normal falling leaves and light debris, however, large, fast or sharp falling items etc. may cause a puncture or tear in the cover material. So, keep the building away from such harmful things. Be careful with power and heat sources. Don't keep heat sources near the tarpaulin. Don't expose to open flame.
4. Chose a windless day to install the building. It is very difficult to attach the cover in heavy wind.
5. All snow accumulation on the main cover should be removed as soon as possible. Otherwise, when old snow on the roof becomes hard with new snow falling in, it will increase the burden of the roof badly and will damage the roof.
6. Try to keep the building, especially its base, in a dry condition. This will help the building to have a longer life than keeping it in a wet condition.
7. The user should be responsible for the parts missing or damage occurred during the installation.
8. Don't make alteration of the frame. Don't hang anything besides included parts to the frame. Damages, consequential damages, or injuries caused by improper installation, alteration, improper use, or damages caused by snow, wind, or any acts of nature are owing to the user. The building is not intended for occupancy for any length of time.

ASSEMBLY PROCEDURE

1. Prepare location and place all unit boxes near location sight. Perform an inventory check before beginning, to be certain all components are available for installation.
2. Secure base plate flanges to base surface.
3. Assemble every group of arch.
4. Begin frame assembly with front end arch, first interior arch, purlins, etc.
5. Add to assemble other groups of arches.
6. Install main cover over frame.
7. Install end covers over end panels.













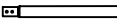
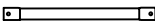

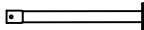

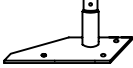









Read all the detailed instructions and notices in the following assembly instructions!

MAINTENANCE AND CARE

1. If some parts or the cover were accidentally damaged during the use, contact the local supplier for advice on the repairing method or replacements, so that to prevent from further damage and keep the building in a good condition.
2. When replacing the parts, make certain the whole frame and the parts connected to the replaced parts be well fixed or supported.
3. Same with when attaching the cover, choose a windless day to replace the cover. Begin with making certain all the bolts of the frame and the tensioning equipments be well fixed. When taking off the cover, make sure the related ropes, etc. be taken off, and the cover will not be blocked during the way. Avoid taking off the cover with heavy big power equipments.
4. To elongate the life of the cover, put small duct tape or foam rubber (provide it by yourself) on the frame that comes to in contact with cover. The tape and foam rubber acts as a cushion to avoid rubbing damage to the cover over years.
5. Periodically (once in half a year or more often), the building should be completely inspected and maintained internally and externally to make certain the building remains properly installed and secured. Including: check all bolts and hardware connectors to be certain they are in place and tightened, the base plates are still fixed firmly, check and adjust the ropes if in need, clean the cover with suitable washing. Allowing dirt and debris to sit on cover over an extended time will damage cover irreparably.

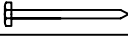
Thanks again for choosing this quality product. The following is the detailed assembly instructions for you starting the assembly.

Part List of Model#Basic-2027(L8.0xW3.5xH3.8m)

Part Code	Description	Quantity	Illustration
1	Top roof curved tube	4	
1A	Top roof curved tube in front panel	1	
2	Roof curved tube	10	
3	Vertical sidewall tubes	10	
4	Horizontal wall and roof purlin	20	
5	Cross tube in front and back panel (2pcs. One set)	2sets	
6	Vertical support tube for cross tube	2	
7	Connection screw for vertical support tube	4	
8	Base flange of back panel	2	
9	Base flange of front panel	2	
10	Base flange in the middle	6	
11	Lower roof cover tensioning tube (pcs. Per set)	2sets	
12	Tie down ratchet	10	
13	Nylon bands of Tie down ratchet	10	
14	Roof cover	1	
15	Carriage bolts M10x90mm for horizontal tube	25	
15A	Hex bolts M10x75mm for arches	60	
15B	Bolts M10x30mm for connection angle	4	
15C	Bolts M10x15mm for tie down ratchets	20	
15D	Bolts M6x40mm for tensioning tube for front and back cover at bottom	2	
16	Connection angle	4	
17	Front cover	1	
18	Tensioning tube for front and back cover at the bottom (2pcs. One set)	2sets	
20	Back cover	1	
21	Door dropping tube	1set	
22	Fastening rope for front&back cover, and two ends of roof cover	5	
24	Stake peg	30	
25	Plastic cap for lower roof cover tensioning tube	10	
27	Windstabilisers on both sides of the shelter	8sets	
28	Pulleys	2	
29	Rope for roll up door	2	
30	Pole for help opening and closing the door	1	

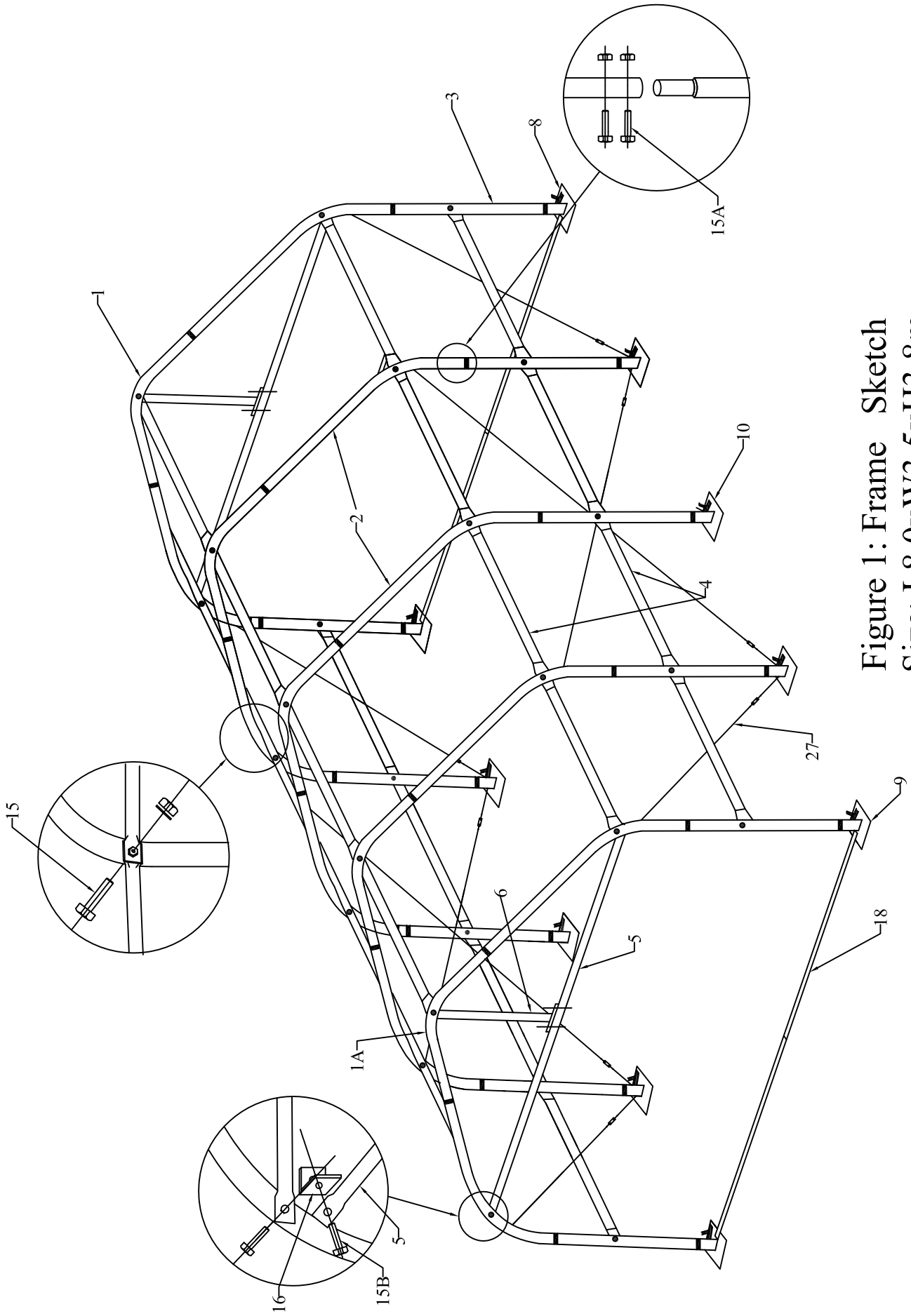

Figure 1: Frame Sketch
Size: L8.0xW3.5xH3.8m

Step #1 --SECURING BASE FLANGES

Sit the building boxes in the chosen location. Remove all the components from packaging to ensure all components are present by checking with the Part List.

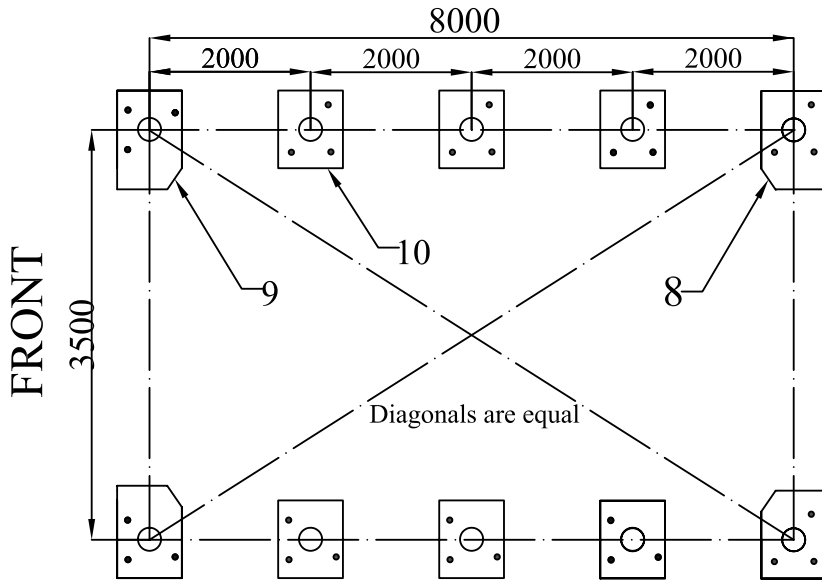

Figure 2 Position of Base Flanges

Begin by determining exact location of the four (4) corners of the building. Mark front edge and side-to-side width of assembly on ground. Drive alignment stakes into the ground outside of the markings, and draw alignment strings along both ends and sides of the building to the dimensions shown in Figure 2. The outline of the strings will represent the final location of the base flanges. The initial location of each Corner Base Flanges is critical to the alignment and fit of the frame components and cover.

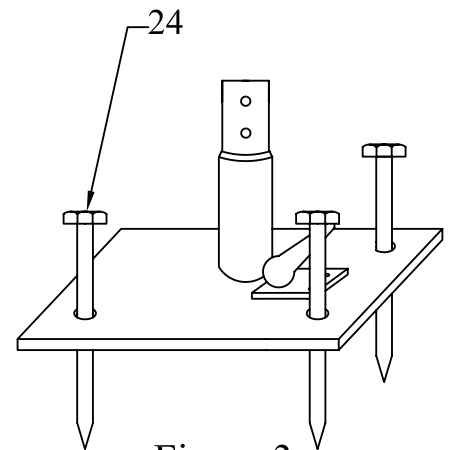

Figure 3

As Figure 3 shows, each base flange is equipped with three stake pegs.

Locate the Left Corner Base Flange and Right Corner Base Flange (part #5). Secure the base flanges with Stake Pegs (Part #24). Measurements shown in Figure 2 are to the center of the upright sockets on each Base Flange.

The Shelter must be secured to a firm surface that can receive and retain stake pegs firmly in position. The shelter should be installed on FIRM GROUND, not on SWAMP, SOFT/WET GROUND. The Base Flanges must be secured so they cannot be moved. Arches are tensioned at their base as they insert into the Base Plate sockets.

Step #2 --ARCH ASSEMBLY

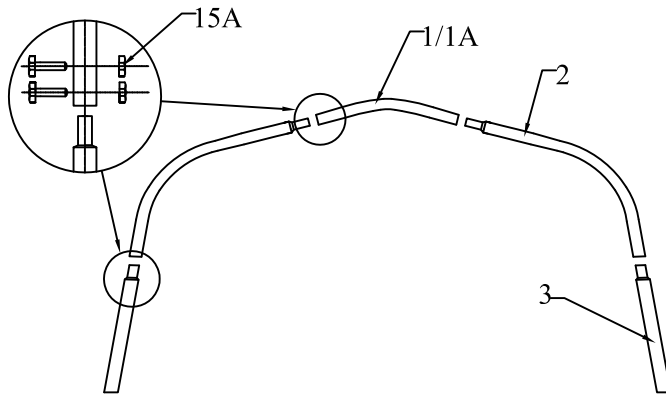

Figure 4 The arch installation

Assemble each arch on ground. Each arches consist of:

One Top roof tube (Part #1/1A)

Two Roof tube (Part # 2)

Two Vertical sidewall tube (Part # 3)

Connect the arches by Using the hexagon bolts with washers and nuts through predrilled holes in frame members. Do not tighten down the nuts completely until frame is fully assembled and set in place.

THE FRONT AND BACK PANEL FRAME ASSEMBLY

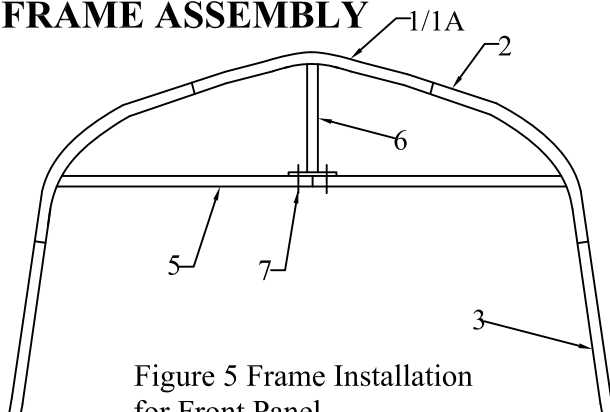

Figure 5 Frame Installation for Front Panel

Assemble the front and back panel frame.

According to Figure 5, connect the end wall frame by Using the bolts with washers and nuts through predrilled holes in frame members. Do not tighten down the nuts completely until frame is fully assembled and set in place.

NOTE: The Arches, the Front and Back panel should be assembled well on the ground, before erected into the Base Flanges.

Step #3 --ERECTING ARCHES

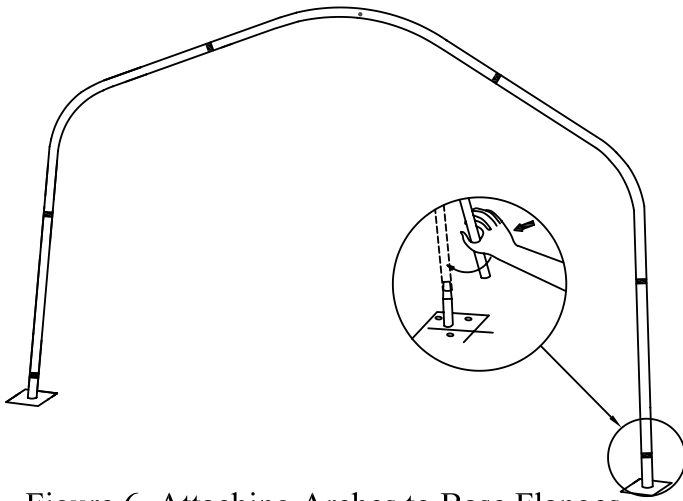

Figure 6 Attaching Arches to Base Flanges

Begin frame assembly by erecting Front Arch into Front Corner Base Flanges. Place left frame sidewall tubing into the upright tube socket into the Left Base Flange. Place Hexagonal Bolt through base flange socket and arch sidewall tube hole.

In order to insert Right Sidewall Tube into Right Front Corner flange, it is necessary to support arch on left side to prevent movement. Position the Right Sidewall Tube over the Right Corner Base Flange.

Once the Right Sidewall Tube is placed into right corner base flange, insert a hexagonal bolt and nut to prevent it from popping out of the socket while assembly continues.

Next stand first interior arch up to repeat insertion into Base flanges.

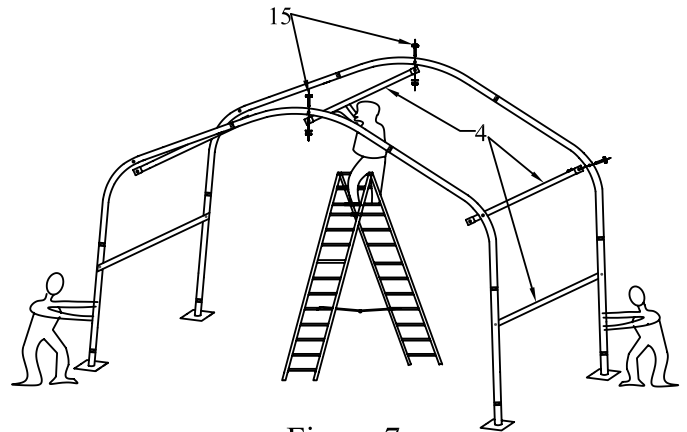

Figure 7

Immediately after putting first interior arch into place, connect Front Arch and Interior arch using Roof Purlin Tubes at top ridge and side shoulder curves of arches. Secure the Roof Purlin tubes into place using carriage bolts and nuts.

Continue to install other Arches Assemblies in the same manner. Overlap pinched ends of Roof Purlin onto same carriage bolts inside frame assembly.

Next check entire frame assembly for square and plumb. Next tighten frame bolts adequately. **DO NOT** over tighten bolts so as to oval or compress frame components.

Step #4 --BOLT RATCHETS TO BASE FLANGES

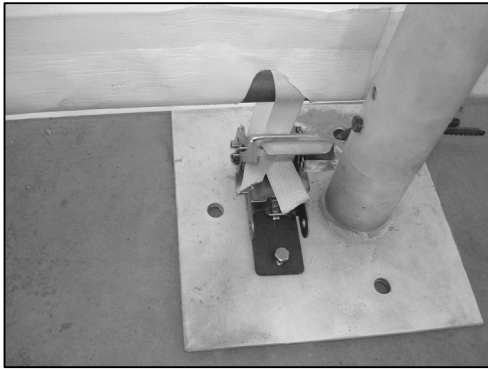

Attach Tie Down Ratchet to each Base Flange along Sidewall. Use two Bolts M10x15 for each sidewall ratchet to secure to Base Flange.

ROOF COVER INSTALLATION

Step #5 --POSITION ROOF COVER

As figure 8 shows, when ready to install Roof Cover, unpack cover and lay parallel to building frame on one side. Cover must be pulled over top of frame assembly without being snagged or stressed on any frame members. Use multiple ropes over top of frame as shown in picture below. Having another person inside frame on a ladder to assist in getting Roof Cover over frame will insure the cover will go on without any damage.

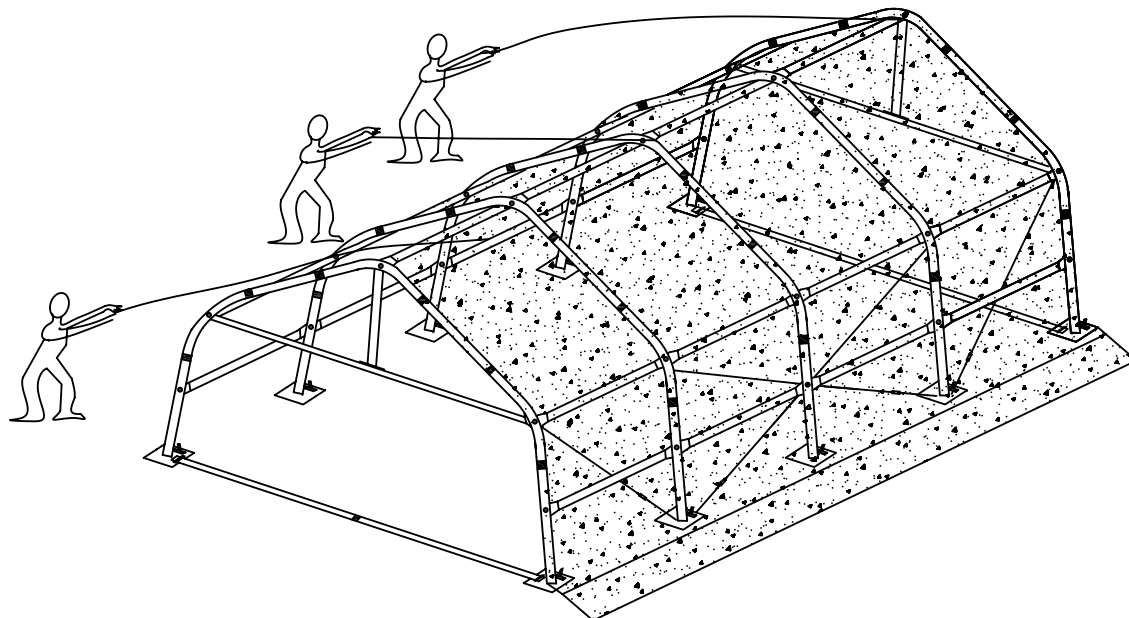

Figure 8: Pull the Roof Cover over the frame evenly

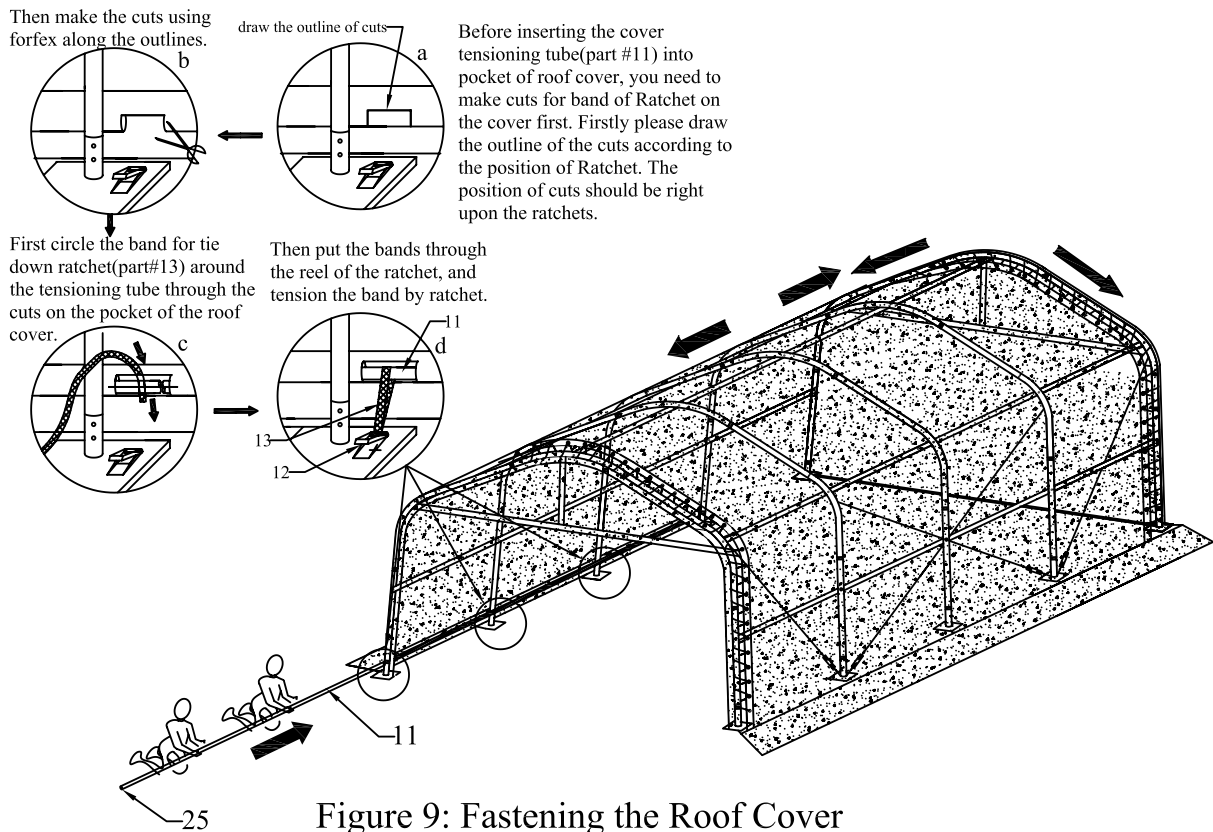

Figure 9: Fastening the Roof Cover

Step #6 --TENSION COVER ON FRAME FROM SIDE-TO-SIDE

As Figure 9 shows, when Roof Cover is over top of Frame Assembly, insert Cover Tensioning Tubes into pockets along both sides of Roof Cover. Center Roof Cover over Frame assembly both side to side and front to back. Align one side of Roof Cover evenly front to back. Add Band for Tie Down Ratchet at each point along the cover opening, as shown. Put Band for Tie Down Ratchets over Cover Tensioning Tubes at each Base Plate along one side. Bands do not attach to Tensioning Tubes, but loop around and secure at both ends on ratchet.

Next take up slack in tie bands by ratcheting the mechanisms, tightening cover. Evenly adjust ratchets on both sides of roof cover to take wrinkles out of roof cover. **DO NOT** fully tighten cover yet. Leave adequate slack so that cover can also be adjusted front to back in next step.

Step #7 --TIGHTEN ROOF COVER ON FRAME FRONT TO BACK

The roof cover is tensioned from front to back by the rope lacing to grommet flaps inside the main cover, inside the unit at both front and rear arches. Using the rope provided, lace the main cover grommet flap around the main frame front and rear arch pieces. Start in the top middle of each arch, and lace to each side. Add rope length by tying pieces together or cutting as necessary.

Lace all grommets on cover inside flap with rope. Starting at the middle top point over the door, tighten lacing only enough to take wrinkles out of the cover. Repeat for the Rear Arch. **DO NOT** over tighten lacing to pull out the grommets.

After the roof cover lacing is adjusted evenly across the grommet flap, go back and re-adjust the Tensioning Ratchets along the side edges of the Roof Cover. At this point, the main cover can be pulled taut enough to take all excess material and wrinkles out of cover. It will be necessary to repeat this step 2-3 weeks after unit assembly is complete and roof over has a chance to stretch out over the frame completely.

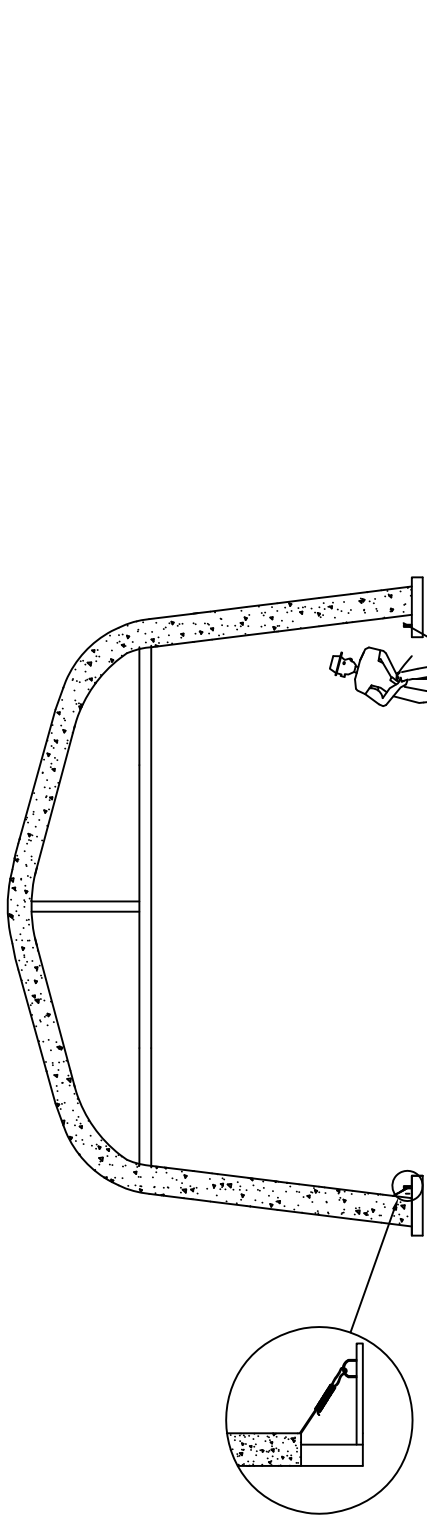

Figure 10 Fastening the two ends of the Roof Cover

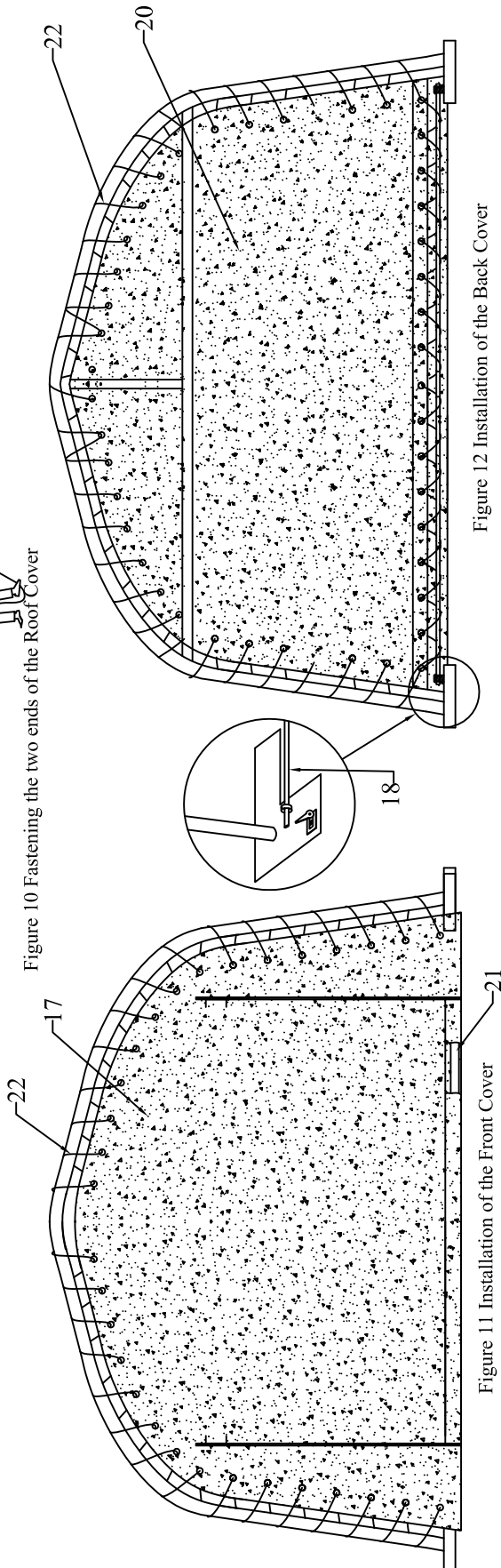

Figure 11 Installation of the Front Cover

Figure 12 Installation of the Back Cover

Step #8 --ASSEMBLE FRONT & REAR COVER

Secure the Front and Back Cover to the arch panel by using the ropes provided.

Main Cover Edge Tie Off -

Once both Front and Rear Covers are installed, the Roof Cover Edge flap, front and rear, should be tightened and tied off. Begin by pulling the remaining Roof Cover over the Frame arch, so the rope pocket is over the edge of the frame. Tie off the rope that goes through the rope pocket on one side. The rope ties off to the loop that is located on the Base Flange in Corner. Moving to the other side, begin to pull the rope down.

Hold the rope in hand, and push down at the bottom of the rope with a foot. Pull the rope tight, and tie off to the welded hoop on the Base Flange. As you are pulling the edge rope, it will be necessary to adjust the excess material that will collect along the rope packet. Adjust the material so that it is not bunched up and it does not pull the roof cover to one side or the other. Once the Front is completed, repeat the process on the Rear flap of the Roof Cover.

ROLL UP DOOR KIT INSTALLATION

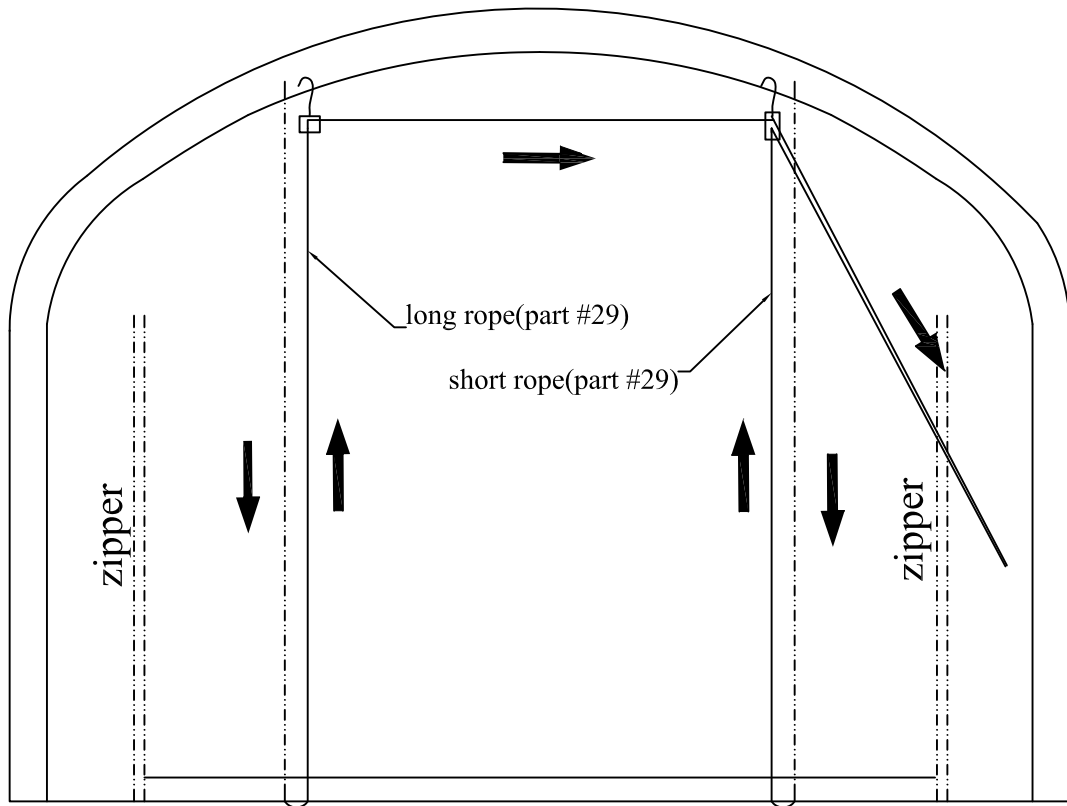

Step 1 Insert the door dropping tubing(part #21) into Pocket along Bottom edge of Roll Up Door.

Step 2 The two pulleys (part #28) should be installed on the outside edge of the Top roof curved tube in front panel(part #1A). Please installed the two pulleys on the tab of the roof curved tube.

Step 3 Attach 2 pieces of ropes for roll up door(part #29) on the inside tab of the top roof curved tube(part #1A), tie the ends into a knot to avoid slipping later. Run the two ropes along the inside of the door and then under the door to the outside of the unit. Thread the rope up through the pulleys and back down.



Step 4 Pull the two rope ends to the side of the door, pulling the ropes together, door will start to roll up. Door may need an adjustment getting start to "roll" rather than bunch up. Once it has been rolled a few times, the fabric will develop a memory to roll. Pull ropes to open door to any position or level needed, then tie the ends of ropes on the tubing.