

DANCOVER[®]

.com

Manual

Storage tent PRO

8x12x4,4m PVC

DANCOVER[®]

.com

Safety Advice

Attention

In some countries approval is needed to set up a marquee/tent larger than 75 m². It is your responsibility to comply with local rules and regulations and to ensure that the marquee/tent is assembled correctly.

In case of bad weather conditions, it is your responsibility to ensure the marquee/tent is safely secured and that the marquee/tent does not cause damage to others.

Do not use open fire, welding equipment or other sources which can ignite, inside or close to the tent.

The marquee/tent must be safely secured. We recommend you secure your marquee/tent with straps and pegs as soon as it is assembled.

Make sure to check if the marquee/tent is covered by your home contents insurance.









Marquees/tents must be evacuated under extreme weather conditions.

In the event of snow always remove snow from the roof of the marquee/tent regularly to prevent snow from building on the roof as heavy snow can cause the marquee/tent to collapse.

In the event of rain there is a risk of rain puddles building up on top of the roof of the marquee/tent. Heavy rain puddles can cause the roof to collapse. It is your responsibility to ensure rain puddles do not build up. As a precaution, make sure the roof of the marquee/tent is stretched out properly and adequately over the side frames of the marquee/tent and remove rain water regularly.





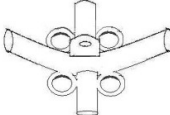
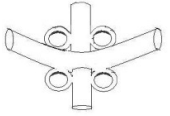
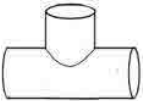

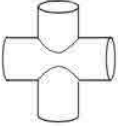

Please always check our website for the latest safety advice and manual.

8x12m Storage Tent

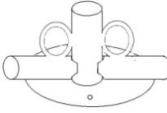
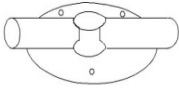
Description	ID Nummer		Quantity
Pipe 1483 mm 50-50 with holes at the bottom	1		14
Pipe 1912 mm 38-38 with one hole each side	2		50
Pipe 1960 mm 50-50 with one hole each side	3		28
Pipe 750 mm roof enforcement 8-series vertical	4		7
Pipe 1987 mm roof enforcement 8-series horizontal	5		14
Pipe 1483mm 50-50 with holes	6		14
Connector 3-way 110° 54-42 with rings	7		4
Connector 3-way 140° 54-42 with sheet+rings	8		2
Connector 4-way 140° 54-42 with sheet+rings	9		5
Connector 4-way 110° 54-42 with rings	10		10
Connector 3-way flat 54-42 with sheet	11		4



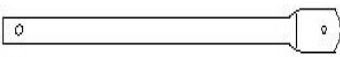
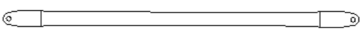





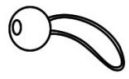

12-09-2013

8x12m Storage Tent

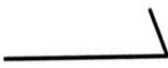
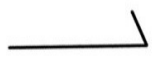
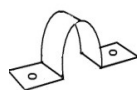
Connector 4-way flat 54-42 with sheet	12		10
Foot 3-way 54-42 endwall side right with ring	13		2
Foot 3-way 54-42 endwall side left with ring	14		2
Foot 3-way 54-42 sidewall side with rings	15		10
Foot 3-way 42-42 endwall side	16		6
Foot 3-way 42-42 endwall side	17		4
Groundbar on end	18		4
Groundbar on end	19		4
Pillar	20		4
Pillar	21		4
Pillar rail	22		4
Tension bar	23		12





12-09-2013

8x12m Storage Tent

Steelwire buckle set for side	24		8
Steelwire buckle set for roof	25		12
Bungee 14 cm type 1	26		164
Peg spiral	27		4
Peg 8x300 mm	28		20
Peg 4x180 mm	29		48
Floor Bracket	30		12
Nail 40cm	31		24
Rope 5 m	32		4
Spanner hex	33		1
Screw M6x30 mm	34		28
M6 wing nut	35		28

12-09-2013

8x12m Storage Tent

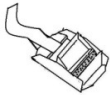
Screw M8X50 mm	36		102
Screw M8X70 mm	37		112
M8 wing nut	38		214
Tit down	39		4
Steel clip	40		36
Roof	41		1
End wall	42		2

12-09-2013

8x12m Storage Tent

I
Select a flat ground for the tent, unpack the carton and check all the parts including tubes, tent and accessories... etc. are present as same as list.
Assemble the framework of rooftop by joining the portion (7.8.9.10.11.12.) together with poles (2.3). To ensure the screw fixed to every pole tightly.

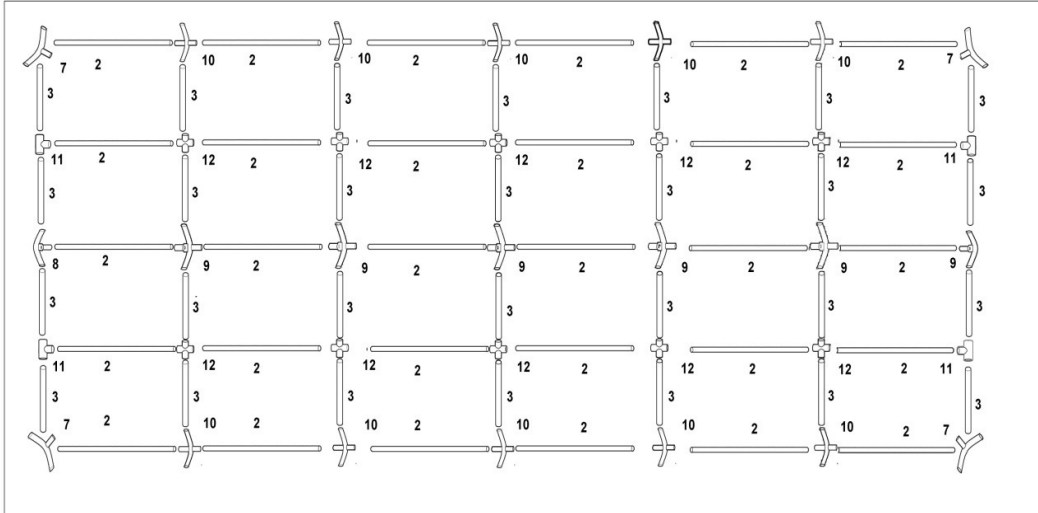

II
Attach one end of supported pole (4.5) to the joints (8.11.9.12)

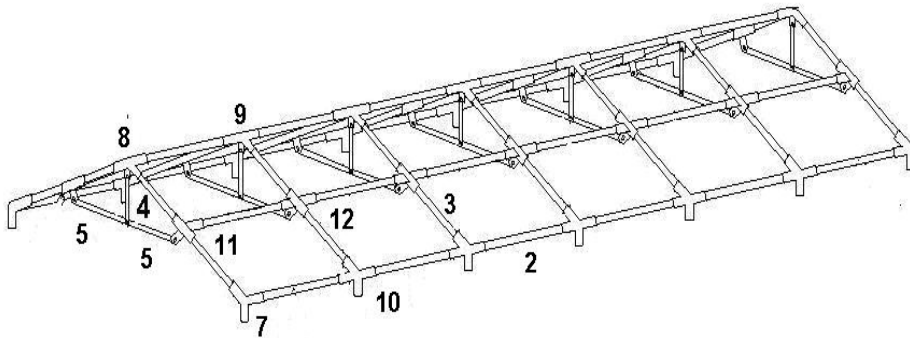

Fastening the roof by using turnbuckle set (25) which are diagonally across through each two sections as shown below.

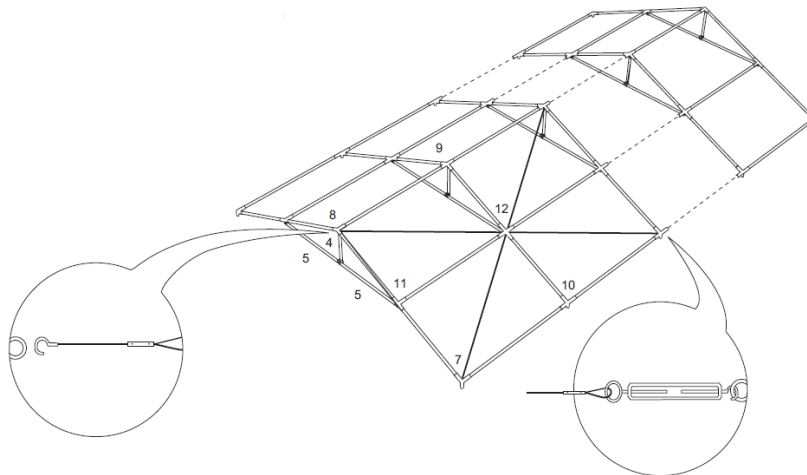

8x12m Storage Tent

III

Attach 7 pcs legs (no.6) to raise the tent on one side, then the other 7 pcs legs (no.6) on the other side. And repeat this step to fix the other 14 pcs legs. Use steel wires to complete the structure like below. Fix the ground bar and pillars like shown on the picture below.

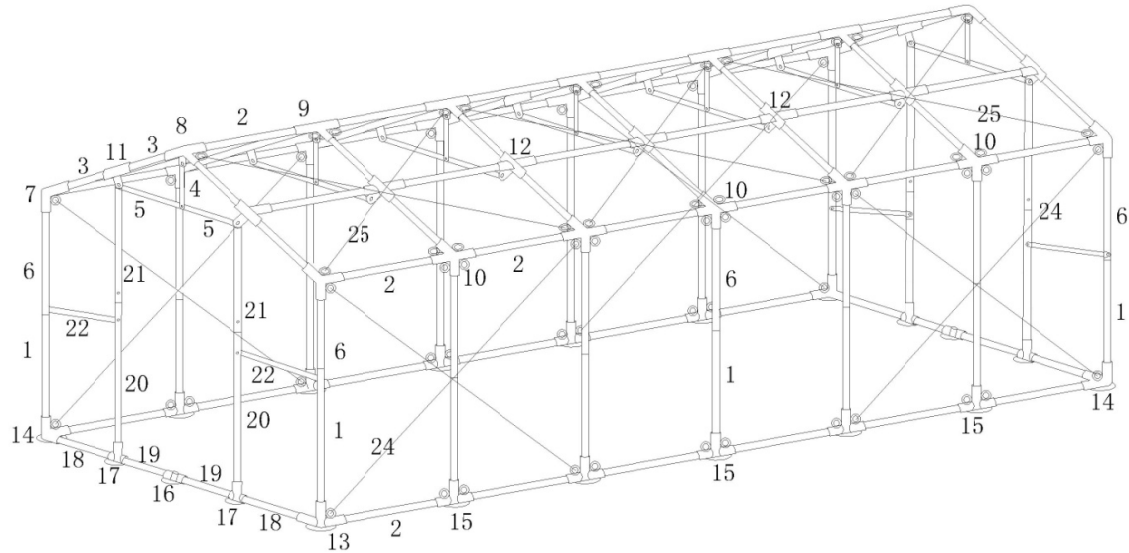

IV

You facilitate the assembly and dismantling by pulling the roof with ropes over the tent frame. Use the steel clips to fasten the cover to the frame. In each section use brackets and nails to fasten the frame to ground.

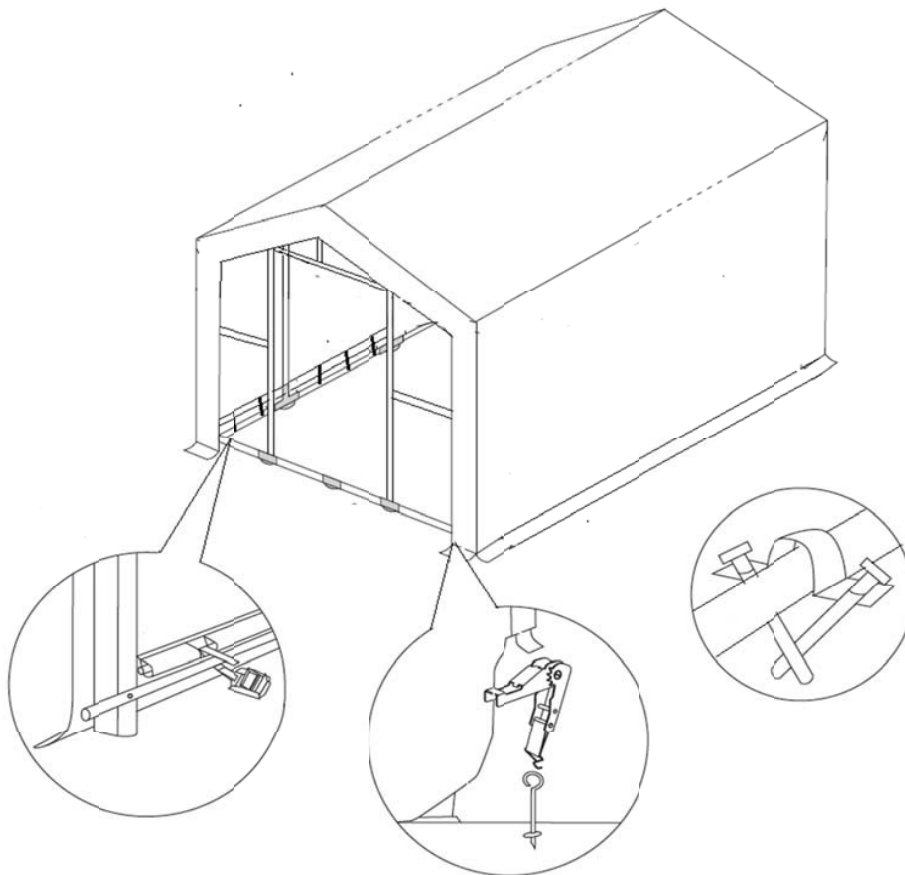

8x12m Storage Tent

V

Spread the wall panel and door panel attach to framework by using the bungee cords clasp the frame to grommets that is construct over the wall panel and door panel to ensure stability. Also use the short pegs to fix the doors to the ground.

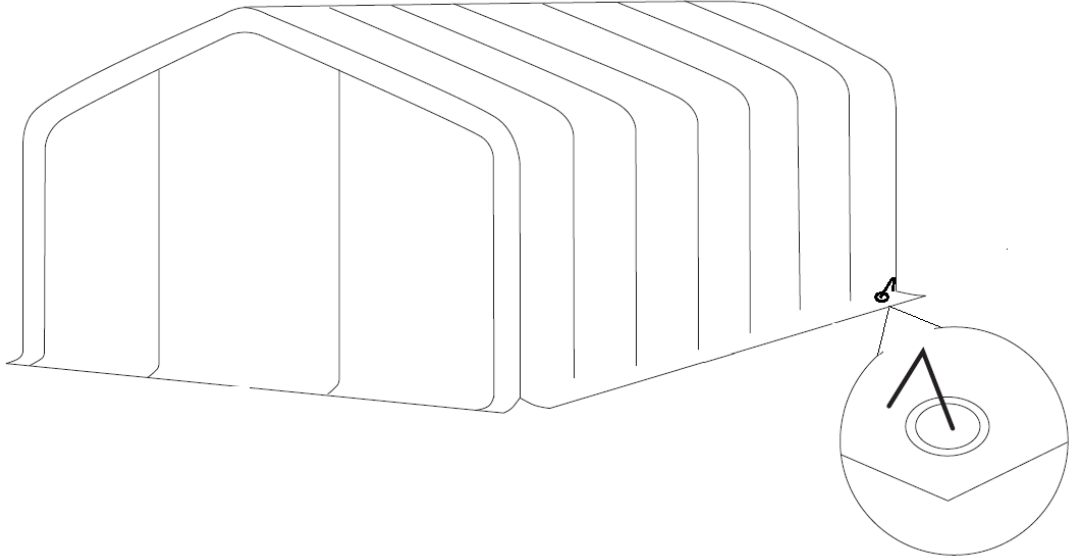

Warning

1. In order to avoid rust, oil is covered on the surface of the pipes. Before setting up the tent, please remove the oil carefully to keep the cover clean.
2. Take note that the tent needs to be handled carefully to avoid damage.
3. Do not force the frame as it may be damaged in the process.
4. Tents are meant as temporary shelter and must be evacuated under extreme weather conditions.

Please select a suitable site for the tent to avoid damage to underground sprinkler systems, water, gas or electrical lines.

Contact information

Head office:

Dancover A/S
Nordre Strandvej 119 G
3150 Hellebæk
Denmark

For more information
please visit:
www.dancovershop.com

National contact

Denmark:

denmark@dancover.com

UK:

uk@dancover.com

Germany:

germany@dancover.com

France:

france@dancover.com

Sweden:

sverige@dancover.com

Finland:

suomi@dancover.com

Poland:

polska@dancover.com

Luxembourg:

luxembourg@dancover.com

Spain:

espana@dancover.com

Italy:

italia@dancover.com

Switzerland:

schweiz@dancover.com

Austria:

austria@dancover.com

Norway:

norge@dancover.com

Nederland:

nederland@dancover.com

Ireland:

ireland@dancover.com

Belgium:

belgique@dancover.com