

DANCOVER[®]



PARTY TENT SEMI PRO

4m series

DANCOVER[®]

.com

Safety Advice

Attention

In some countries approval is needed to set up a marquee/tent larger than 75 m². It is your responsibility to comply with local rules and regulations and to ensure that the marquee/tent is assembled correctly.

In case of bad weather conditions, it is your responsibility to ensure the marquee/tent is safely secured and that the marquee/tent does not cause damage to others.

Do not use open fire, welding equipment or other sources which can ignite, inside or close to the tent.

The marquee/tent must be safely secured. We recommend you secure your marquee/tent with straps and pegs as soon as it is assembled.

Make sure to check if the marquee/tent is covered by your home contents insurance.

Marquees/tents must be evacuated under extreme weather conditions.

In the event of snow always remove snow from the roof of the marquee/tent regularly to prevent snow from building on the roof as heavy snow can cause the marquee/tent to collapse.

In the event of rain there is a risk of rain puddles building up on top of the roof of the marquee/tent. Heavy rain puddles can cause the roof to collapse. It is your responsibility to ensure rain puddles do not build up. As a precaution, make sure the roof of the marquee/tent is stretched out properly and adequately over the side frames of the marquee/tent and remove rain water regularly.

Do not unpack or repack your marquee/tent in freezing temperatures. In case of temperatures below zero always unpack and repack your marquee/tent indoors to avoid the risk of cracking parts.

The marquee/tent must be totally dry before you repack and store it to avoid mildew.









Note: Marquees are intended for events and other arrangements and are as such only meant for short term temporary assembly and the following disassembly. Dancover warranty applies only to the normal use of the Product, normal wear and tear excepted, in accordance with written use instructions or manual. The warranty does not apply to damage caused by accident, abuse, misuse, or modification of the Product.

Warranty Information

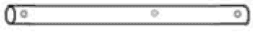
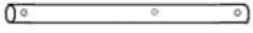



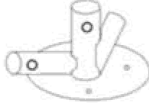

Please visit dancovershop.com for information on warranty.

Please always check our website for the latest safety advice and manual.



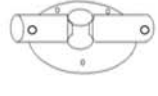



4m -2.3 PARTY TENT SEMI PRO

Dimention		NO	4 x6	4 x8	4 x10	4 x12	4 x14
Pipe 2188mm 50-50 with holes		1	4	6	8	10	12
Pipe 1880mm 38-38		2	15	20	25	30	35
Pipe 1880mm 38-38 with hole		3-1	2	2	2	2	2
Pipe 1880mm 38-38 with hole		3-2	2	2	2	2	2
Pipe 2030mm 50-50		4	8	10	12	14	16
Pipe 1174 mm 25-25		6	4	4	4	4	4
Pipe 2188mm 50-50 with holes and a hole		8	4	4	4	4	4
connector Three way 120°54-42		15-1 (A)	6	6	6	6	6
connector four way 120 °54-42		15-2 (B)	6	9	12	15	18
Connector three way –foot for the corners 54-42		16	2	2	2	2	2



4m -2.3 PARTY TENT SEMI PRO

Connector three way –foot for the corners 54-42		17	2	2	2	2	2
Connector three way –foot for the sidewalls 54-42		18	4	6	8	10	12
Connector three way –foot for the endwalls 54-42		19	2	2	2	2	2
Groundpegs		20	4	6	8	10	10
Screw hook		21	4	4	4	4	4
Groundpeg 6x180mm		22	8	10	12	14	16
Groundpeg 4x180mm		23	36	42	48	54	60

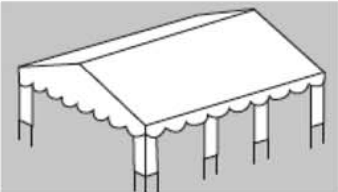
4m -2.3 PARTY TENT SEMI PRO

Screw M8X45mm		24	47	52	57	62	67
Screw M8X60mm		25	36	44	52	60	68
Locknuts		26	83	96	109	122	135
Long bungeeball		33	86	102	118	134	150
Short bungeeball		34	18	18	18	18	18
rope		35	4	4	4	4	2
roof		37	1	1	1	1	1

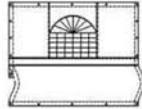
4m -2.3 PARTY TENT SEMI PRO

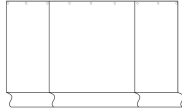
sidewall		38	6	8	10	12	14
Endwall with Large door		39	1	1	1	1	1
Endwall with Small door		40	1	1	1	1	1

4m -2.3 PARTY TENT SEMI PRO

I
Select a flat surface for the tent.
Unpack the boxes and check that all listed parts are included.
Assemble the roof frame by mounting parts 15-1 and 15-2 on the pipes (2,3-1,3-2 and 4).
Use the screws to firmly attach the parts.

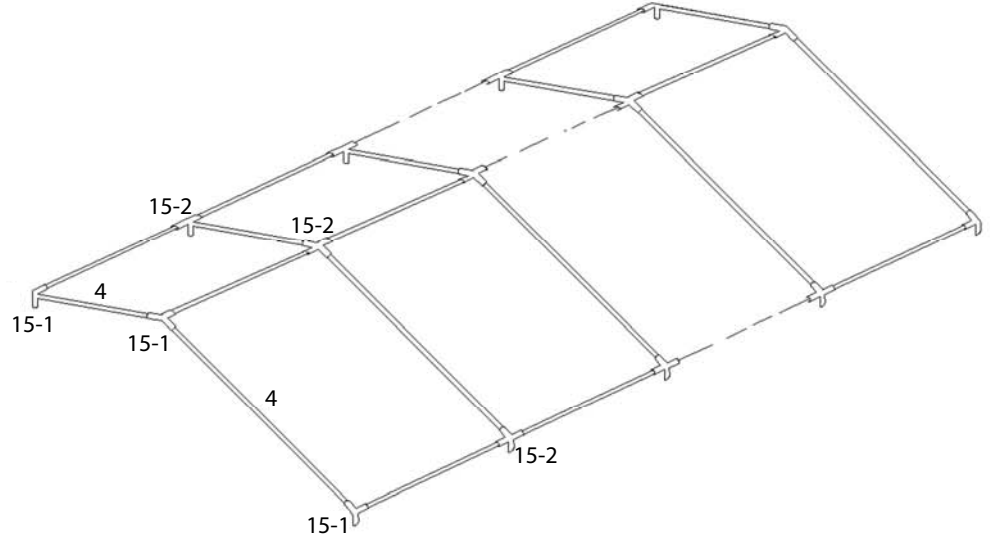
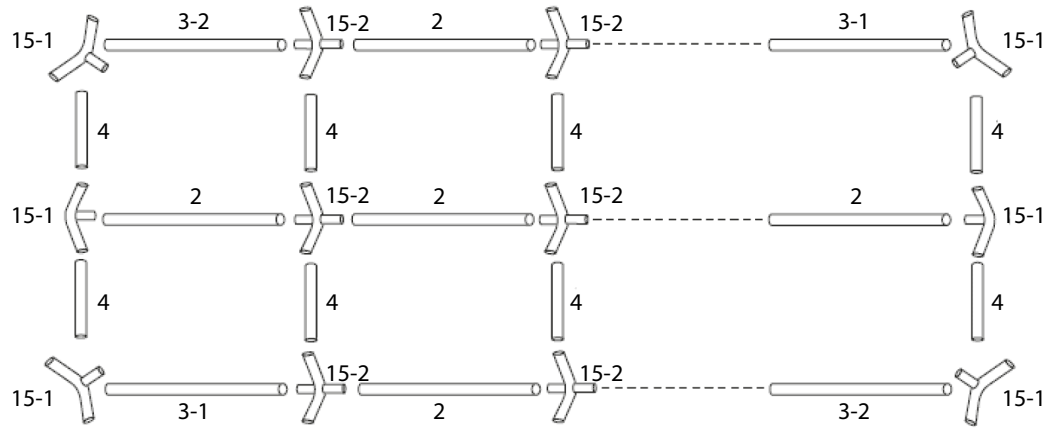

4m -2.3 PARTY TENT SEMI PRO

II

Lift one side of the tent frame and attach the legs(1). Attach the legs with part no. 8 to the outside in all four corners. Place the roof onto the frame and use the bungees to fasten it. Be sure not to put too much tension on the bungees in order not to make attaching the other side more difficult.

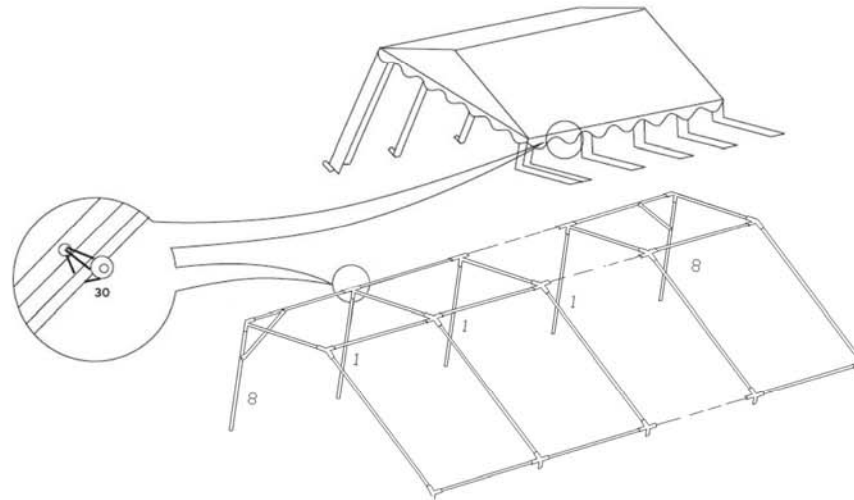

III

Attach the legs on the other side and install the feet(16,17,18,19) at the bottom. Use the long ground pegs to fasten the feet to the ground. Attach the side covers to the pipes(1,8). Connect leg cover with sidewall and endwall by velcro as shown. Reinforce the side frame by attaching the diagonal pipes(6) to all four corners. Complete the bottom frame with the required pipes (2) and connector (16,17,18,19).

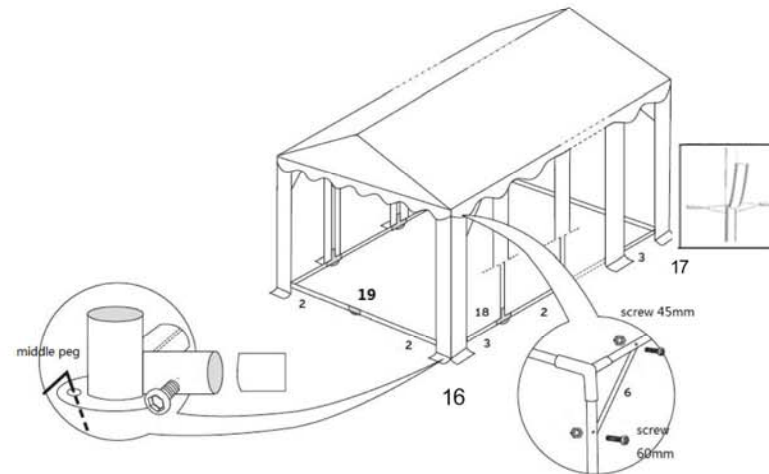

4m -2.3 PARTY TENT SEMI PRO

IV

Extend the sidewalls and the endwalls and attach the sidewalls to the frame using the bungees. Attach the endwall directly to the roof using the short bungees. Use the short ground pegs to fasten the end walls to the ground. The guy rope runs from every corner of the tent and is braced to the ground using the screw hooks. The professional ground pegs provide the tent with additional tension and stability.

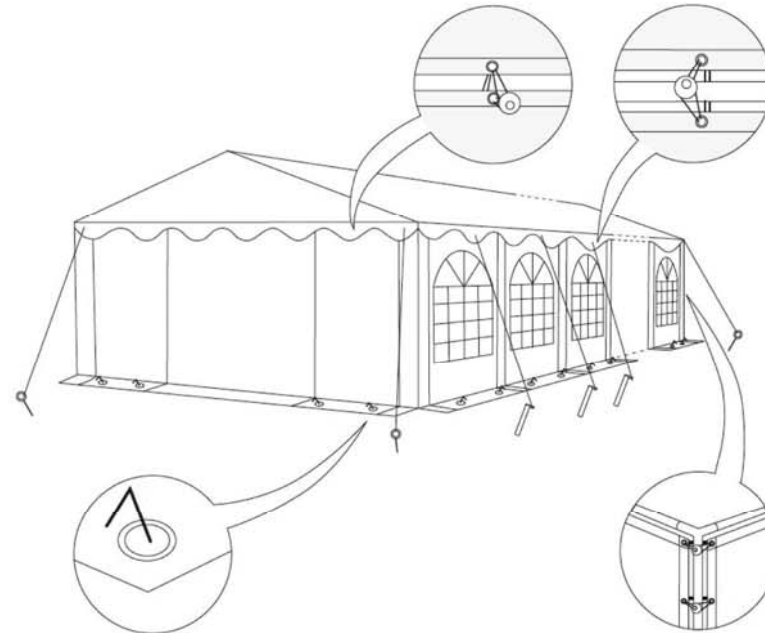

Warning

1. In order to avoid being rusted by air, oil is covered on the surface of the pipes, before set up the tent, please remove the oil carefully to keep the cover clean.
 2. Take note that the tent needs to be handled carefully to avoid damage.
 3. Do not force the frame as they may be damaged in the process.
 4. Tents are meant as temporary shelter and must be evacuated under extreme weather conditions.
- Please select a suitable site for the tent to avoid the damage to underground sprinkler systems, water, gas or electrical lines.

Contact information

Head office:

Dancover A/S
Nordre Strandvej 119 G
3150 Hellebæk
Denmark

For more information
please visit:
www.dancovershop.com

National contact

Denmark:

denmark@dancover.com

UK:

uk@dancover.com

Germany:

germany@dancover.com

France:

france@dancover.com

Sweden:

sverige@dancover.com

Finland:

suomi@dancover.com

Poland:

polska@dancover.com

Luxembourg:

luxembourg@dancover.com

Spain:

espana@dancover.com

Italy:

italia@dancover.com

Switzerland:

schweiz@dancover.com

Austria:

austria@dancover.com

Norway:

norge@dancover.com

Nederland:

nederland@dancover.com

Ireland:

ireland@dancover.com

Belgium:

belgique@dancover.com