

DANCOVER[®]



PARTY TENT SEMI PRO

8m series - Side height 2,6m

DANCOVER[®]



Safety Advice

Attention

In some countries approval is needed to set up a marquee/tent larger than 75 m². It is your responsibility to comply with local rules and regulations and to ensure that the marquee/tent is assembled correctly.

In case of bad weather conditions, it is your responsibility to ensure the marquee/tent is safely secured and that the marquee/tent does not cause damage to others.

Do not use open fire, welding equipment or other sources which can ignite, inside or close to the tent.

The marquee/tent must be safely secured. We recommend you secure your marquee/tent with straps and pegs as soon as it is assembled.

Make sure to check if the marquee/tent is covered by your home contents insurance.

Marquees/tents must be evacuated under extreme weather conditions.

In the event of snow always remove snow from the roof of the marquee/tent regularly to prevent snow from building on the roof as heavy snow can cause the marquee/tent to collapse.

In the event of rain there is a risk of rain puddles building up on top of the roof of the marquee/tent. Heavy rain puddles can cause the roof to collapse. It is your responsibility to ensure rain puddles do not build up. As a precaution, make sure the roof of the marquee/tent is stretched out properly and adequately over the side frames of the marquee/tent and remove rain water regularly.

Do not unpack or repack your marquee/tent in freezing temperatures. In case of temperatures below zero always unpack and repack your marquee/tent indoors to avoid the risk of cracking parts.







The marquee/tent must be totally dry before you repack and store it to avoid mildew.

Note: Marquees are intended for events and other arrangements and are as such only meant for short term temporary assembly and the following disassembly. Dancover warranty applies only to the normal use of the Product, normal wear and tear excepted, in accordance with written use instructions or manual. The warranty does not apply to damage caused by accident, abuse, misuse, or modification of the Product.

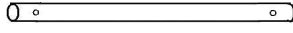

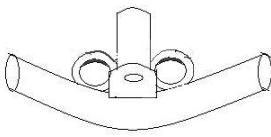
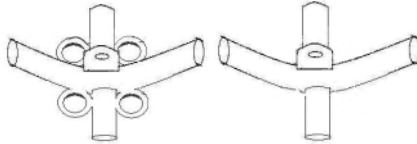
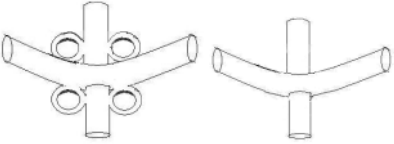

Warranty Information

Please visit dancovershop.com for information on warranty.



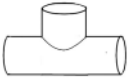
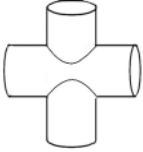
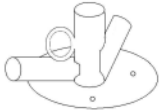

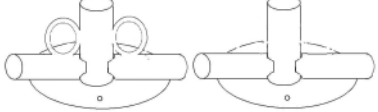
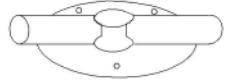

8m Series -2,6 PARTY TENT SEMI PRO

Dimention		No.	8x12m Quantity	8x16m Quantity		
50X1.5MM 2188MM		1	14	18		
37x1.1mm 1880mm		2	50	64		
50X1.5MM 1950MM		3	28	36		
25x0.8mm 750mm		4	7	9		
25x0.8mm 1987mm		5	14	18		
50X1.5MM 400MM		6	14	18		
110° Three-way		7	4	4		
140° Three-way		8	2	2		
140° Four-way		9-1 9-2	2 3	3 4		
110° Four-way		10-1 10-2	4 6 no rings	6 8 no rings		

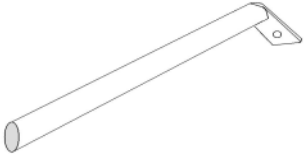

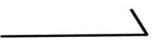

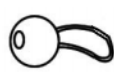
8m Series -2,6 PARTY TENT SEMI PRO

Flat Threeway		11	4	4		
Flat fourway		12	10	14		
Foot base for corner on right		13	2	2		
Foot base for corner on left		14	2	2		
Foot base for sidewall		15-1 15-2	4 6	4 10		
Foot base for endwall		16	6	6		
Turnbuckle set for side		17	8	8		

8m Series -2,6 PARTY TENT SEMI PRO

Turnbuckle set for roof		18	12	16		
surperpeg		19	10	14		
6x300mm spiral		20	4	4		
6x180mm		21	14	16		
4x180mm		22	56	64		
Long bungeeball		23	204	226		
Short bungeeball		24	30	30		
rope		25	4	4		
M6X30mm screw +nut		26	28	36		

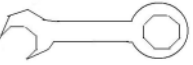
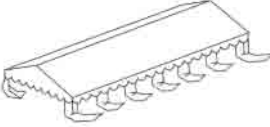
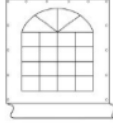
8m Series -2,6 PARTY TENT SEMI PRO

M8x50mm screw		29	100	135		
M8x60mm screw		30	84	106		
locknut		31	184	241		
spancer		32	2	2		
roof		33	1	1		
sidewall		34	12	16		
endwall with large door		35	1	1		
endwall with small door		36	1	1		

8m Series -2,6 PARTY TENT SEMI PRO

I

Select a flat ground for the tent, unpack the carton and check all the parts including tubes, tent and accessories... etc. are present as same as list.

Assemble the framework of rooftop by joining the portion (7.8.9.10.11.12.) together with poles (2.3).To ensure the screw fixed to every pole tightly

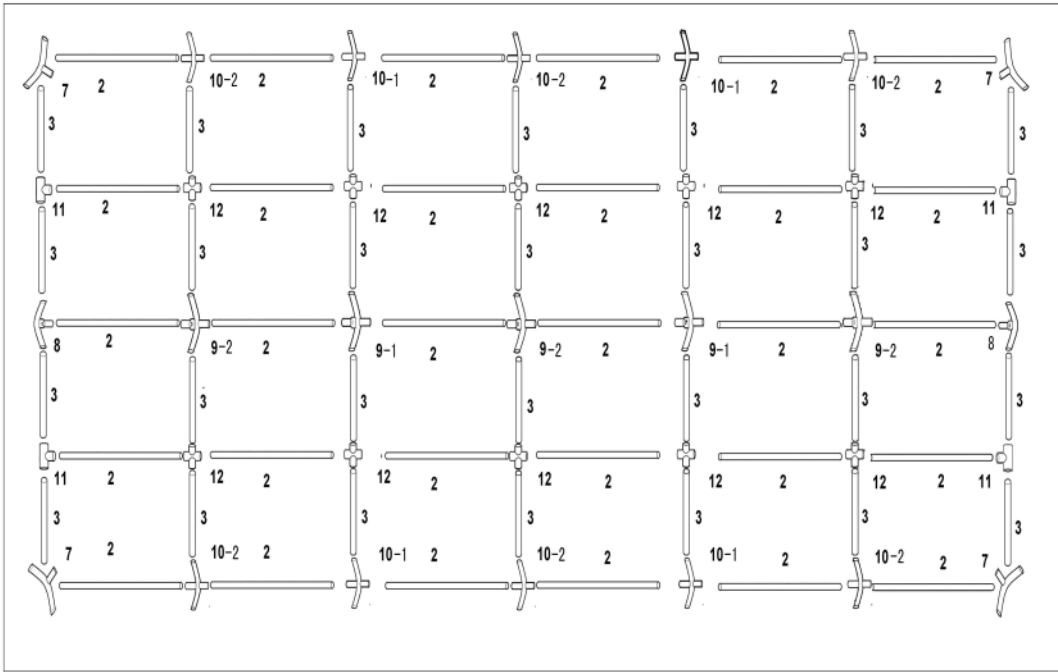

II

Attach one end of supported pole (4.5) to the joints (8.11&9.12)

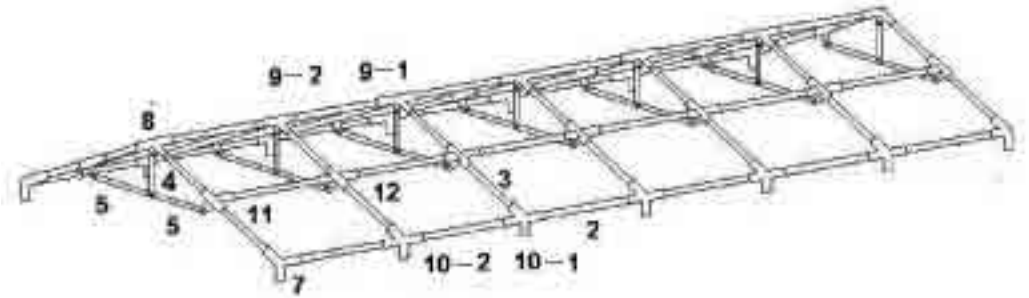

Fastening the roof by using turnbuckle set(18) which is diagonally across through each two section as below .

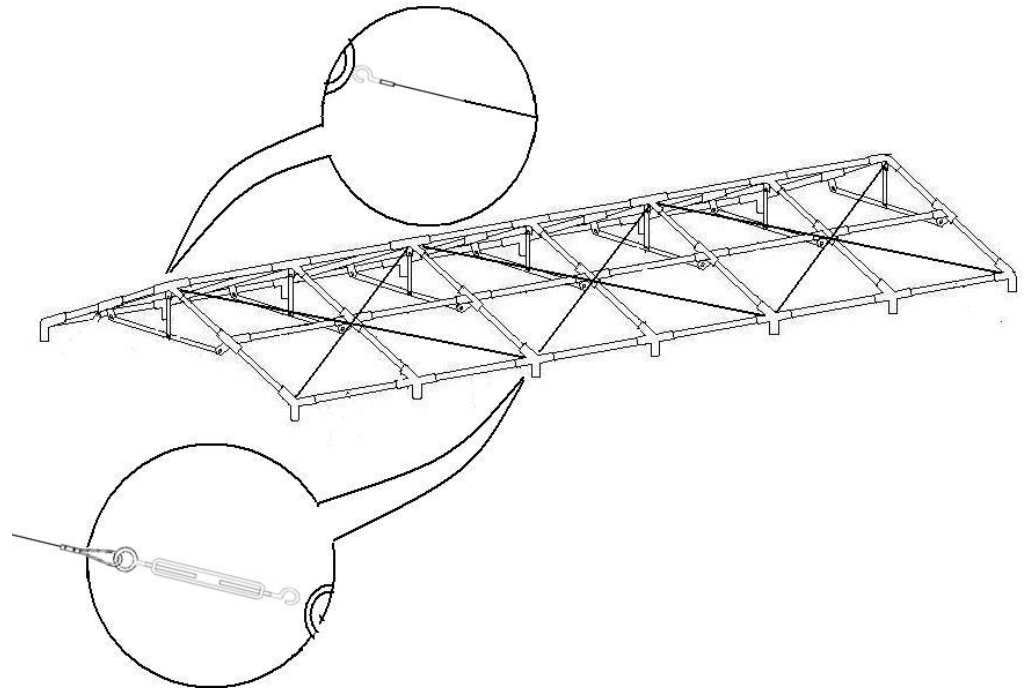

8m Series -2,6 PARTY TENT SEMI PRO

III

Cover the roof on the frame ,and attach it by the bungee balls properly ,take care of the tension of the bungee balls ,for if you use too many on one side of tent ,it may too tight to tie the other side of it .Apply legs in one side as shown.

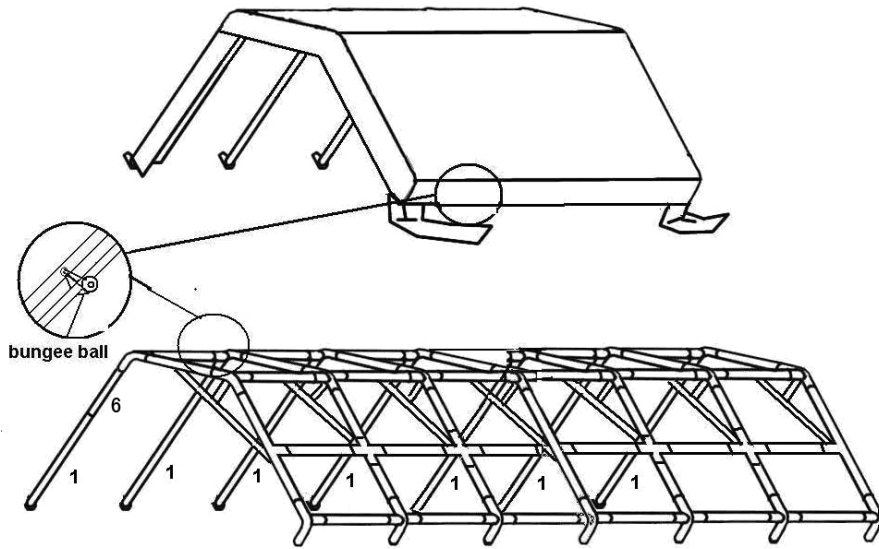

IV

Attach the another supported poles (6) to the joints (7.10), built-up the framework ,use the long peg to fix each pole into the ground and connect leg cover with sidewall and endwall by Velcro as shown .Using turnbuckle sets (17) to fasten the structure just the same as you do on roof ..

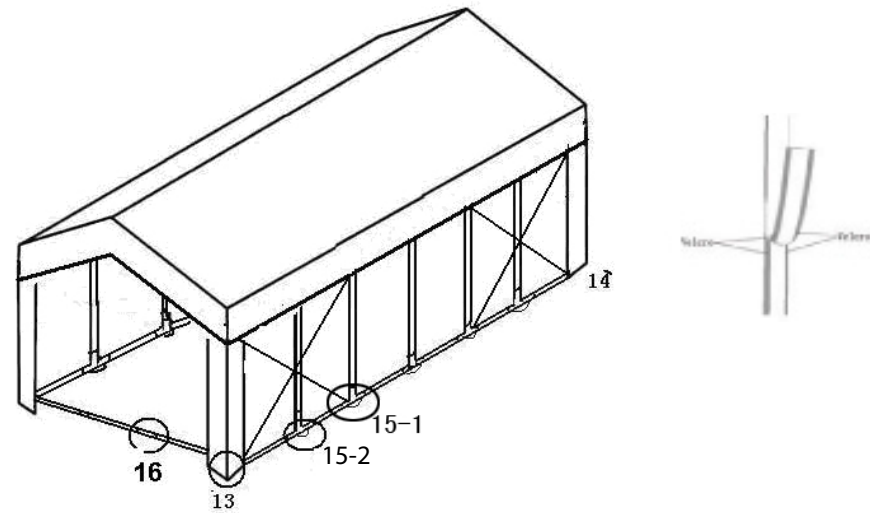

8m Series -2,6 PARTY TENT SEMI PRO

V

spread the wall panel and door panel attach to framework by using the bungee cords clasp the frame to grommets that is construct over the wall panel and door panel to ensure stability. Also use the short pegs to fix the doors to the ground .

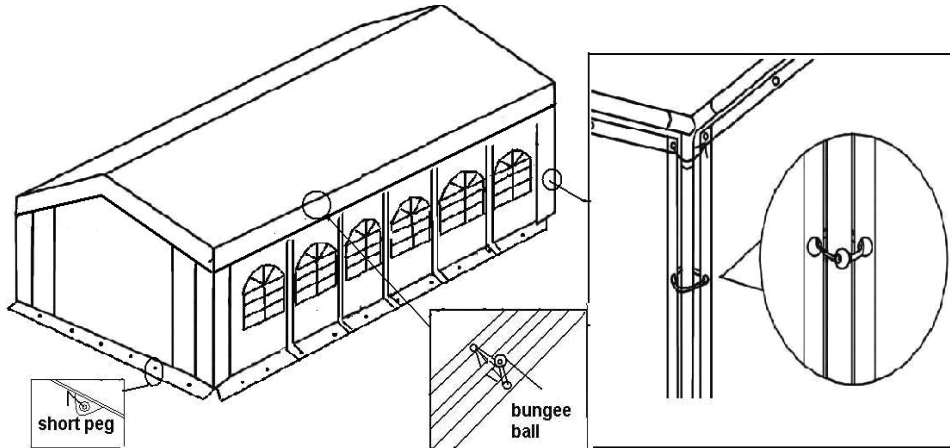

VI

The Guy lines clasp to each corner of tent and another end of line fix to ground by pegs.

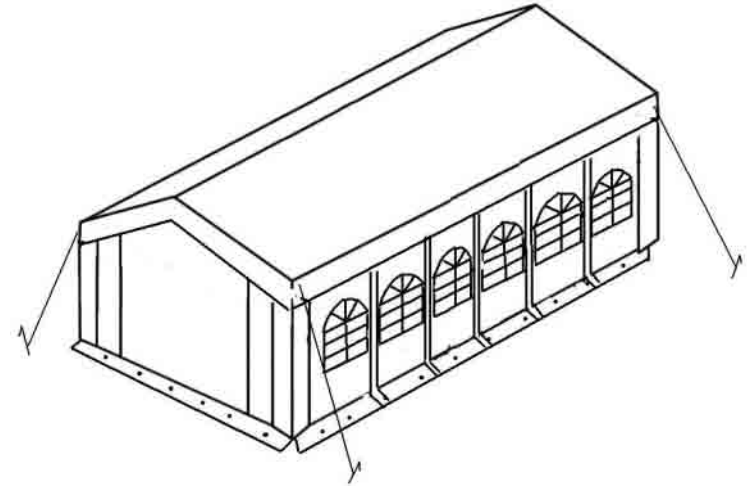

Warning

1. In order to avoid being rusted by air, oil is covered on the surface of the pipes, before set up the tent, please remove the oil carefully first to keep the cover clean.
2. Take note that the tent needs to be handled carefully to avoid damage.
3. Do not force the frame as they may be damage in the process.
4. Tents are meant as temporary shelter and must be evacuated under extreme weather conditions.

Please select a suitable site for the tent to avoid the damage to underground sprinkler systems, water, gas or electrical lines.

Contact information

Head office:

Dancover A/S
Nordre Strandvej 119 G
3150 Hellebæk
Denmark

For more information
please visit:
www.dancovershop.com

National contacts

Denmark: 70 26 76 20
denmark@dancover.com

UK: 020 8099 7570
uk@dancover.com

Germany: 041 0266 7040
germany@dancover.com

France: 0975 181 800
france@dancover.com

Sweden: 040 233 262
sverige@dancover.com

Finland: 0 931 581 720
suomi@dancover.com

Poland: 22 300 8602
polska@dancover.com

Luxembourg: +49 041 0266 7040
luxembourg@dancover.com

Portugal: 308 800 899
portugal@dancover.com

Spain: 911 436 828
espana@dancover.com

Italy: 02 479 21 198
italia@dancover.com

Switzerland: 0840 000125
schweiz@dancover.com

Austria: 0662 626935
austria@dancover.com

Norway: 231 00 690
norge@dancover.com

Nederland: 0 858 880 524
nederland@dancover.com

Ireland: 0 151 33 003
ireland@dancover.com

Belgium: 0 28 08 08 09
belgique@dancover.com