

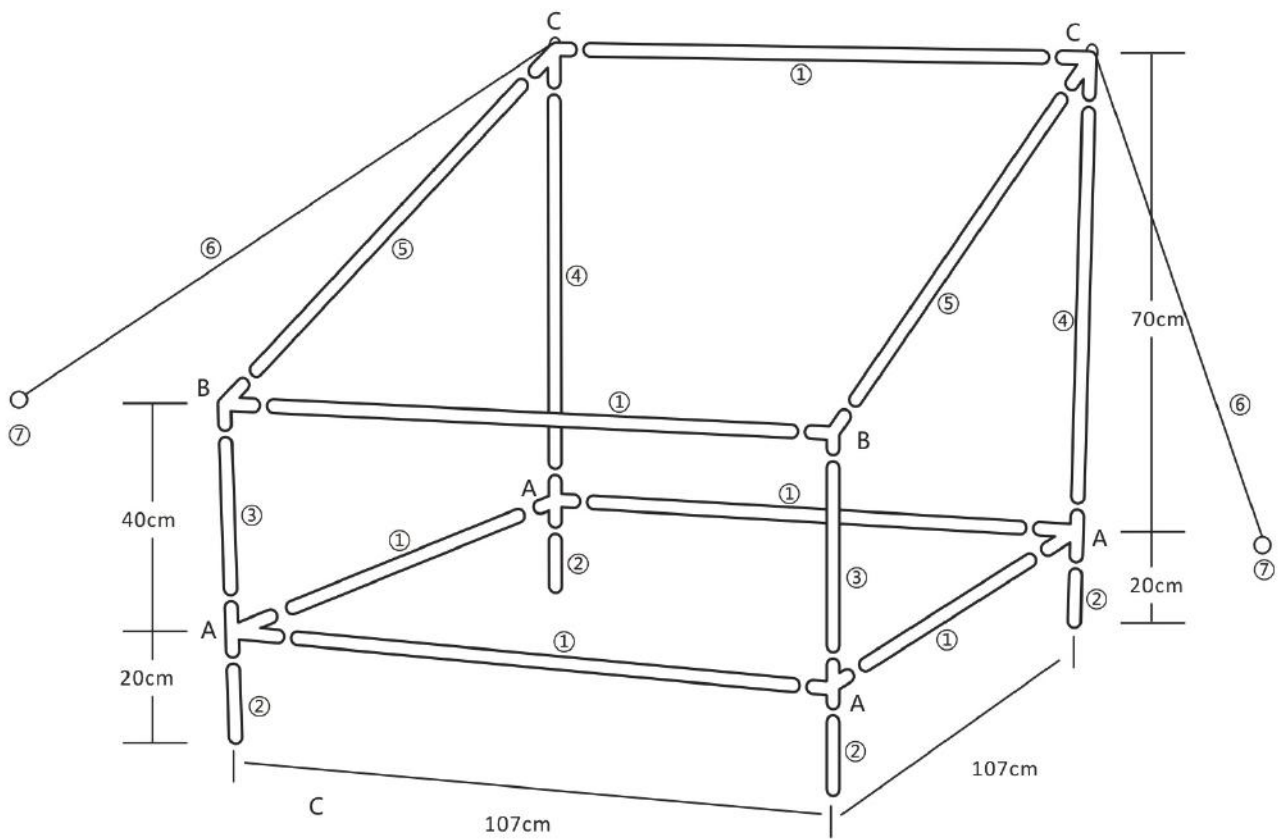







DANCOVER[®]

.com

Manual
for
Mini Greenhouse,
0.7 x 0.7 m

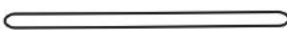
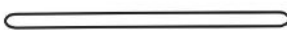

NO		QTY	NO		QTY
①		X6	A		X4
②		X4	B		X2
③		X2	C		X2
④		X2			
⑤		X2			
⑥		X2			
⑦		X2			