

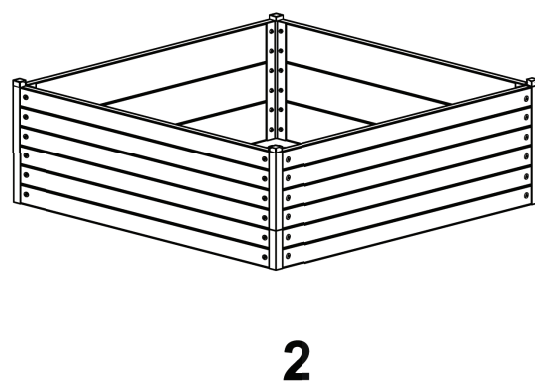

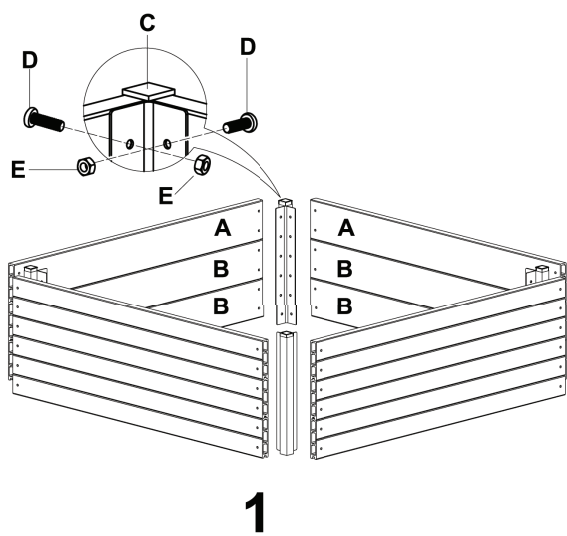

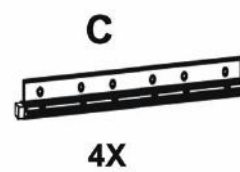

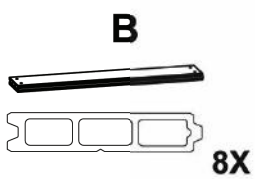

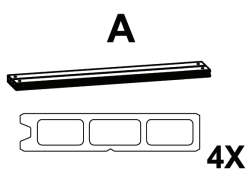
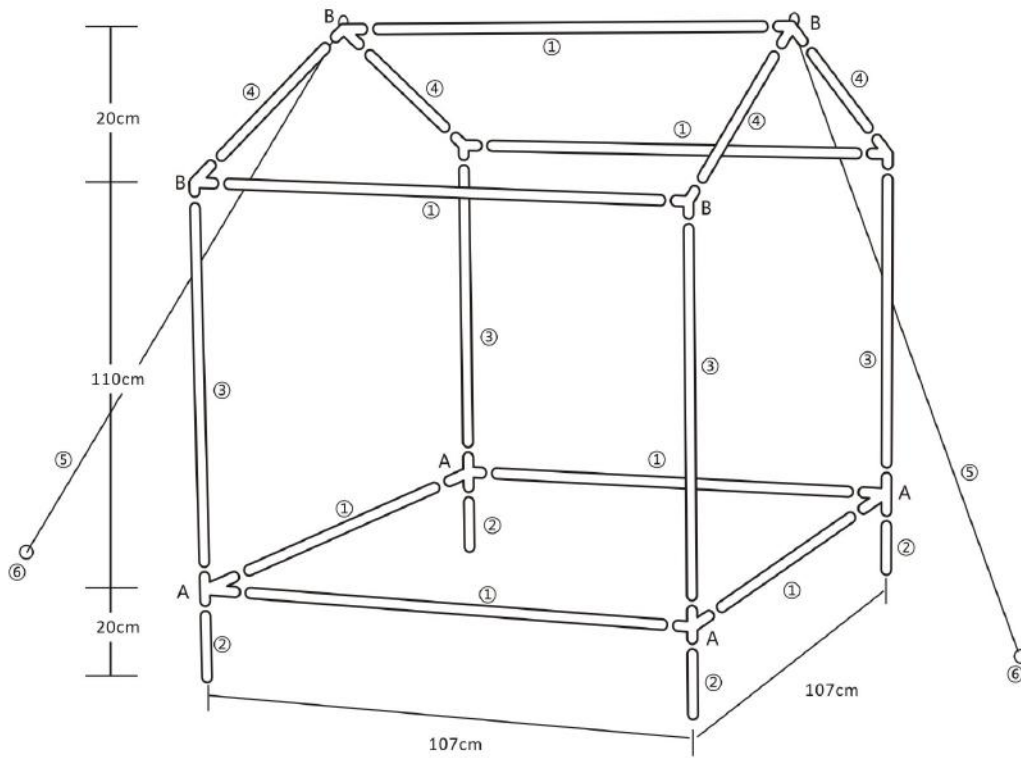

**DANCOVER<sup>®</sup>**

**.com**

Manual  
for  
Raised Flowerbed  
w/Greenhouse,  
1.1 x 1.1 m





NO		QTY	NO		QTY
①		X7	A		X4
②		X4	B		X6
③		X4	C		X5
④		X4			
⑤		X2			
⑥		X2			